









Modular Group



















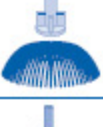











	Description	Packing		
		Qty.	Wt.	Ctn.
	Head only	2,500	9 kg	T
	Head with antimist	1,750	8.5 kg	T
	Head on butterfly	1,100	7 kg	T
	Head with antimist on butterfly	900	7 kg	T
	Head on butterfly with 0.60 m - 4/7 tube	250	7.3 kg	X
	Head with antimist on butterfly with 0.60 m - 4/7 tube	250	7.1 kg	X
	Head on LPD	750	8.5 kg	T
	Head with antimist on LPD	650	8.6 kg	T

The old version of LPD is available on request

How to Order Modular Group Assembly: A=2; B=5 Always

Example:

2	5	C	D	E	F	G	H-I
2	5	7	5	7	0	1	12

C		D		E		F		G		H-I	
Distribution		Swivels		LPD (black)		Nozzles		Butterfly/Base		Stand	
Code				Code		Code	Colour-l/h				
5	Spreaders	1	90° Spreader (black) 	0	w/o Antimist w/o LPD	0	 Brown-43	0	 Butterfly 1/4"	12	0.60 m - 4/7 tube
		2	180° Spreader (red) 	1	LPD M-11 	1	Ivory-235	1	 Butterfly 4/7	13	0.75 m - 4/7 tube
		3	Close-range spreader (orange) 	2	LPD 3/8 	2	Green-105	2	 Butterfly quick thread	15	1.00 m - 4/7 tube
		5	Flat spreader (yellow) 	3	LPD M-11 with Antimist 	3	Blue-200	3	 Butterfly 3/8"	16	1.20 m - 4/7 tube
		6	12 Jets spreader (green) 	4	LPD 3/8" with Antimist 	4	Violet-35	4	 Butterfly parallel	17	1.50 m - 4/7 tube
		7	Strip spreader (blue) 	5	LPD 4/7 barbed with Antimist 	5	Orange-120	5	 Butterfly gray 4/7	81	SUSP 0.30 m
		8	Misting spreader (violet) 	6	Antimist 	6	Yellow-160	6	 Butterfly gray 3/8"	82	SUSP 0.60 m
		6	Swivels	3	Small swivel (black) 	7	LPD 4/7 barbed 	7	Red-260	7	 Base 1/2" BSP
4	Big swivel (orange) 			8	LPD Female 	8	Black-300	8	 Base M-11		
9	Anti-ant swivel (red/black) 			9	LPD female with Antimist 	9	Gray-70				
2	One-side swivel (blue) 										
7	One-side Swivels	3	One-side swivel (black) 								
		5	Inverted swivel (green) 								

Micro-Sprinklers

Assembled units are available according to technical recommendations only.

The old version of LPD is available on request

Modular



Fig.	Item #	Description	Packing		
			Qty.	Wt.	Ctn.
1	850302	Spreaders: 12 jets, green	60,000	10.4 kg	T
2	850308	Spreaders: 90°, black	60,000	10.9 kg	T
3	850303	Spreaders: strip, blue	60,000	10.4 kg	T
4	850314	Spreaders: misting, violet	60,000	10.4 kg	T
5	850305	Spreaders: close-range, orange	80,000	10.5 kg	T
6	850306	Spreaders: flat, yellow	80,000	10.5 kg	T
7	850307	Spreaders: 180°, red (old)	60,000	10.4 kg	T
7	850317	Spreaders: 180°, red (new)	15,000	10 kg	T
8	850218	Swivels: small, black	10,000	7.4 kg	T
9	850215	Swivels: big, orange	10,000	8.4 kg	T
10	850202	Swivels: Inverted, green	10,000	8 kg	T
11-a	850217	Swivels: insect-proof, spreader, red	10,000	10.5 kg	T
11-b	850220	Swivels: insect-proof, cup, black	15,000	15 kg	U
12	850208	Swivels: one-side, black	10,000	8 kg	T
12	850228	Swivels: one-side, blue	10,000	8 kg	T
13	850600	Bridge	3,000	8 kg	T
14	85010X	Nozzle	65,000	10 kg	T
15	85001X	Anti-mist	5,000	6.5 kg	T
16	850090	Deflector	4,500	5 kg	U

Micro Stands

With barb 4/7



Item #	Description	Packing		
		Qty.	Wt.	Ctn.
797006	Micro stand 60 cm	600	15 kg	X
797008	Micro stand 75 cm	500	13.4 kg	X
797014	Micro stand 100 cm	300	8.8 kg	X
797016	Micro stand 120 cm	300	13.2 kg	X
797018	Micro stand 150 cm			

Butterfly Stands

With butterfly 4/7 and barb 4/7



Item #	Description	Packing		
		Qty.	Wt.	Ctn.
797030	Butterfly stand 60 cm	400	10.2 kg	X
797032	Butterfly stand 75 cm	300	9.2 kg	X
797038	Butterfly stand 100 cm	200	8.3 kg	X
797040	Butterfly stand 120 cm	200	9.4 kg	X
797042	Butterfly stand 150 cm	150	8.8 kg	X



Spikes

	Item #	Description	Packing		
			Qty.	Wt.	Ctn.
1	897908	Spike 31 black	550	11.5 kg	U
1	897907	Spike 31 red	550	11.5 kg	U
2	897948	Spike 37 black	170	6.5 kg	U
2	897947	Spike 37 red	170	6.5 kg	U
Available on special request only					
3	897918	Spike 34 black	170	5 kg	U
3	897917	Spike 34 red	170	5 kg	U
4	897938	Spike 36 black	230	6 kg	U
4	897937	Spike 36 red	230	6 kg	U

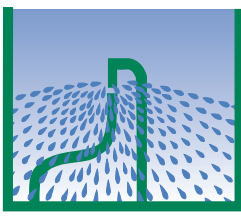

Stands for Micro-Sprinklers

Suspended Stands

With barb 4/7

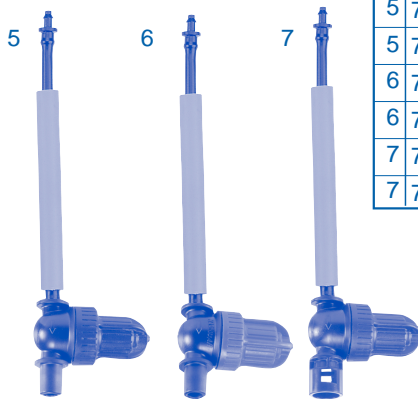
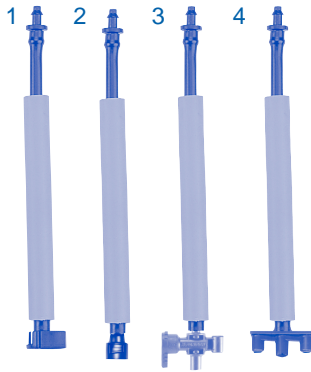

Item #	Description	Packing			
		Qty.	Wt.	Ctn.	
1	797124	Suspended stand 30 cm and "fast-n-fast"	300	13.3 kg	T
1	797129	Suspended stand 60 cm and "fast-n-fast"	300	16.7 kg	X
2	797403	Suspended stand 30 cm for 7110 Hadar	300	13.3 kg	T
2	797405	Suspended stand 60 cm for 7110 Hadar	300	16.7 kg	X
3	797340	Suspended stand 30 cm + mini valve for Modular	No standard packing		
3	797343	Suspended stand 60 cm + mini valve for Modular			
4	797140	Suspended stand 30 cm and butterfly			
4	797143	Suspended stand 60 cm and butterfly			
5	797443	Suspended stand 30 cm + Super LPD, black for Modular			
5	797446	Suspended stand 60 cm + Super LPD, black for Modular			
6	797453	Suspended stand 30 cm + Super LPD, blue for Fogger			
6	797456	Suspended stand 60 cm + Super LPD, blue for Fogger			
7	797463	Suspended stand 30 cm + bayonet Super LPD, black			
7	797466	Suspended stand 60 cm + bayonet Super LPD, black			

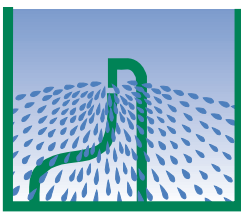

Suspended Stands



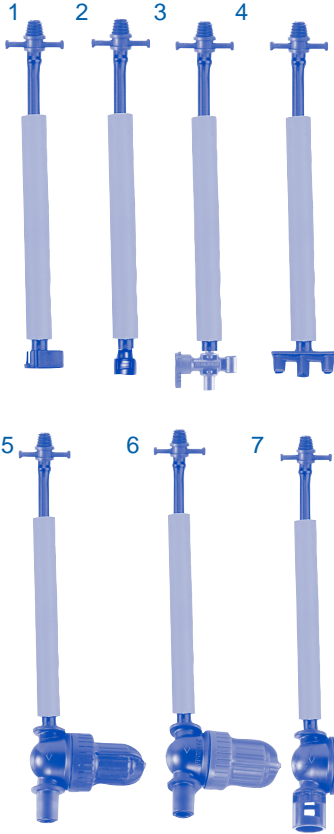



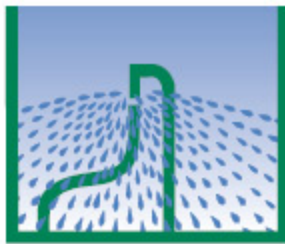























With butterfly 3/8"



	Item #	Description	Packing		
			Qty.	Wt.	Ctn.
	1	797190	Suspended stand 30 cm and "fast-n-fast"	No standard packing	
	1	797192	Suspended stand 60 cm and "fast-n-fast"		
	2	797423	Suspended stand 30 cm for 7110 Hadar		
	2	797426	Suspended stand 60 cm for 7110 Hadar		
	3	797363	Suspended stand 30 cm + mini valve for Modular		
	3	797366	Suspended stand 60 cm + mini valve for Modular		
	4	797180	Suspended stand 30 cm and butterfly		
	4	797182	Suspended stand 60 cm and butterfly		
	5	797473	Suspended stand 30 cm + Super LPD, black for Modular		
	5	797476	Suspended stand 60 cm + Super LPD, black for Modular		
	6	797483	Suspended stand 30 cm + Super LPD, blue for Fogger		
	6	797486	Suspended stand 60 cm + Super LPD, blue for Fogger		
	7	797493	Suspended stand 30 cm + bayonet Super LPD, black		
	7	797496	Suspended stand 60 cm + bayonet Super LPD, black		



Accessories for Micro-Sprinklers

	Item #	Description	Packing		
			Qty.	Wt.	Ctn.
	1	897030	5000	8.9kg	T
	2	897010	3000	8.4 kg	T
	3	750070			
	4	897016	4000	10 kg	T
	5	897019	3000	8.3 kg	T
	6	897017	3000	7 kg	T
	7	897012	4500	9.5 kg	T
	8	897002	2000	9 kg	T
	9	897001	1300	8 kg	T
	10	897108	500	7 kg	U
	11	897112	500	7.5 kg	U
	12	790308	1500	11 kg	T
	13	790328	1500	11.2 kg	T
	14	790338	1500	11.5 kg	T
	15	790048	1500	11.5 kg	T
	16	790303	1500	11.2 kg	T
	17	790323	1500	11.2 kg	T
	18	790333	1500	11 kg	T
	19	790343	1500	11 kg	T
	20	790228	1500	11.2 kg	T
	21	790238	1500	11 kg	T
	22	790248	1500	11 kg	T
	23	897053	600	18.6 kg	U
	24	897032	15,000	10.6 kg	T
	25	897055	10,000	10 kg	T
	26	790100	4500	11 kg	T
	27	897272	550	5.2 kg	T
	28	897270	270	5 kg	T
	29	890300	40,000	12 kg	T
	30	769308			
	31	769208			