

**Controller
Models
SL800
SL1600
SL4800**

Owner's Manual

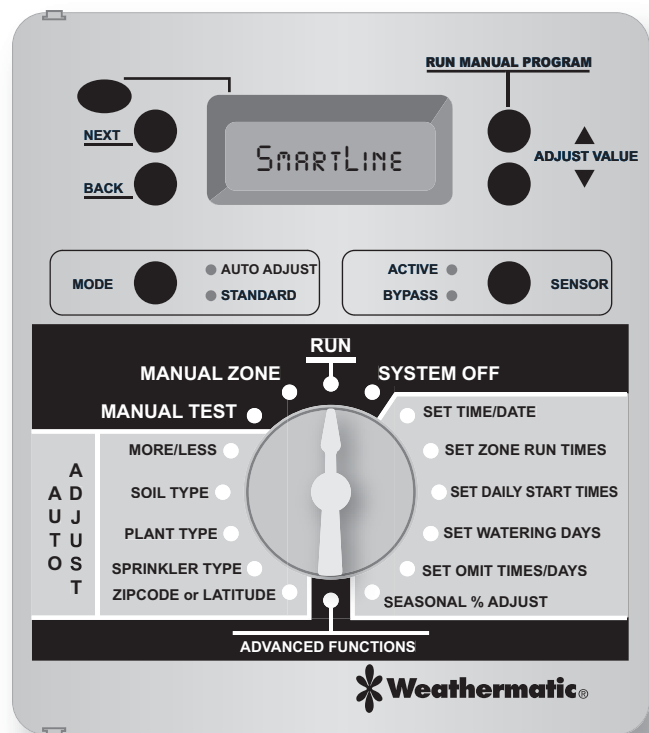

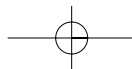

Introduction

SMARTLINE

Congratulations! Your SmartLine irrigation controller is designed to maintain the health and quality of your landscape while conserving water to minimize your operation costs. The SmartLine controller can perform Standard timed watering schedules or, with the addition of the optional SLW Series On-Site Weather Monitor, the controller's Auto Adjust mode will analyze "on site" weather data to automatically set optimum watering times for each zone, based on Weathermatic's patented methodology. Auto Adjust will also save water by automatically setting run and soak cycles to minimize runoff.

ATTENTION INSTALLER:

PLEASE READ BEFORE INSTALLING AND SAVE THIS MANUAL FOR SYSTEM OWNER.

U.S. Patent No. 6,314,340

TRADEMARKS:

Weathermatic
SmartLine
Smart Solutions for the Professional

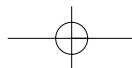
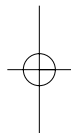

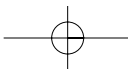

SMARTLINE

Table of Contents

1.0 Accessories	1	6.3.3 TEMPDATA	18
2.0 Getting Acquainted With Your Smartline Controller	2	6.3.4 TOTL RUN	18
2.1 Getting Acquainted With Your Smartline Control Panel	2	6.3.5 CLR TOTL	19
2.2 Programming	4	6.3.6 CLR DFCITS	19
3.0 Programming For Standard Watering Mode	6	6.4 RAIN DLY	19
3.1 Set Time and Date	6	6.5 RUN/SOAK	19
3.2 Set Zone Run Times	6	6.6 ZN:ZN DLY	19
3.3 Set Daily Start Times	7	6.7 MV:ZN DLY	20
3.4 Set Watering Days	7	6.8 MV/ZONE	20
3.5 Set Omit Times/Days/Dates	8	6.9 CLR PGM	20
3.6 Seasonal % Adjust	9	6.10 Wireless	20
4.0 Programming For Auto Adjust Watering Mode	10	6.11 About	20
5.0 Manual Start Functions	14	7.0 Troubleshooting	21
6.0 Advanced Functions	15	7.1 Total Reset Procedure For Your Smartline Controller	21
6.1 FAULT	15	7.2 Replacing SLW Series Weather Monitor 9V Battery	21
6.2 TESTS	17	7.3 Troubleshooting Checklist	21
6.2.1 OUTPUTS	17	Appendix	
6.2.2 BATTERY	17	Chart of World Latitudes	25
6.2.3 24V PWR	17		
6.2.4 LOCATOR	17		
6.3 REVIEW	17		
6.3.1 NEXT RUN	17		
6.3.2 DEFICIT	18		

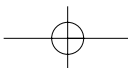
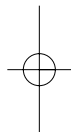

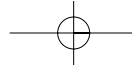

1.0 Accessories

SMARTLINE

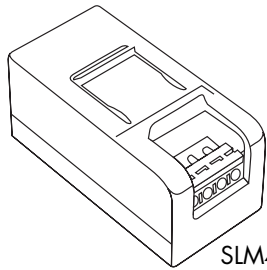

SLM4

Modules

SLM4 4-Zone Module
for SL1600 and SL4800

SLM2 2-Zone Module
for SL800

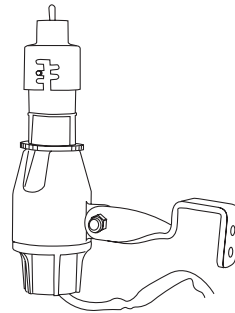

No. 955 Rain Sense

Rain Sensor for use when
SLW Series On-Site Weather
Monitor is NOT installed.

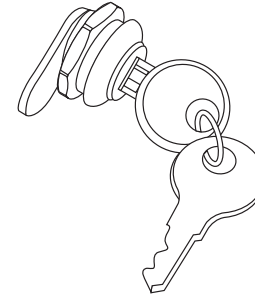

SLK

Door Lock



SLW20

SLW Series On-Site Weather Monitor
SmartLine weather monitor with rain
and freeze sensing

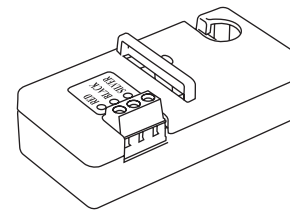

SLHUB

SmartLine communication hub

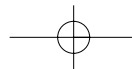

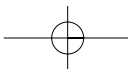

SMARTLINE Getting acquainted with your Smartline Controller 2.0

2.1 Getting Acquainted With Your SmartLine Control Panel

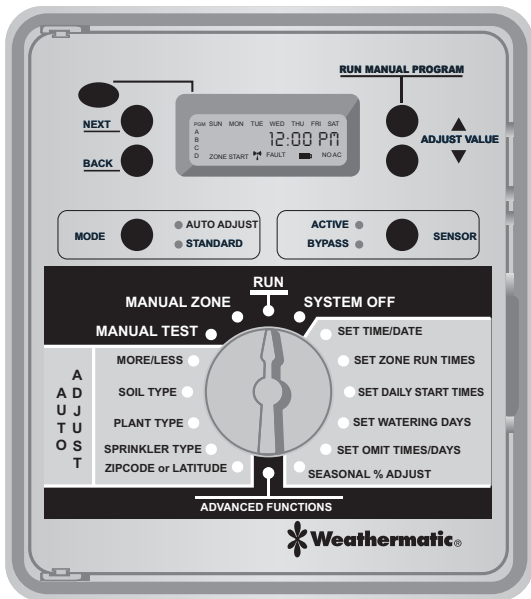

Time of Day

Battery Strength: If battery icon is solid black, the battery strength is good. If the icon is an outline, you should replace the battery. The SmartLine controller utilizes a 9V alkaline battery to maintain correct time during a power failure. AC power is required to operate valves, but the 9V battery will temporarily power the processor and display.



Note: If you are utilizing the optional SLW Series On-Site Weather Monitor, you can also use the same display icon to check the status of the 9V alkaline battery in the SLW weather monitor. If you turn the dial to any Auto Adjust position, the display battery icon will show strength for the SLW weather monitor battery.

Communications: If you are utilizing the optional SLW

Series On-Site Weather Monitor, an antenna icon on the display indicates a good link between the SLW weather monitor and the SmartLine controller. If the antenna bands are flashing, this indicates communication has occurred within the last 5 minutes. If no communication has occurred for 5 days, the antenna icon will disappear and the SmartLine controller will utilize zone run times programmed in the Standard watering mode.



SmartLine Controller LCD Display

Provides the following information when the controller is set to RUN, SYSTEM OFF, or when there is no active watering operation underway (display with program in IDLE mode):



Next Watering Day or Days: The display will show the watering day or days in the current week for Program A. To view watering days for Program B, C or D just press the PGM button.

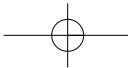

2.0 Getting acquainted with your Smartline Controller

SMARTLINE

Fault Indicator: Appears ONLY when a fault is detected. Turn dial to Advanced Functions to view faults. Once you turn the dial to Advanced Functions, the fault indicator will stop flashing but will continue to appear on the screen until the fault is removed or user clears fault in Advanced Functions. If fault is cleared in Advanced Functions, it will appear again the next time the program runs if the fault is not corrected.

No AC: Appears when there is no AC supply to the controller.

PGM Button: The SmartLine controller has 4 watering programs (A, B, C, and D). This is like having 4 controllers in one. You can assign zones to any program you like or more than one program except that zones assigned to Program D cannot be given a run time in A, B, or C. Program D will operate concurrently with A, B, or C. Display will alternately show both programs while the concurrent schedule is running. Program D is normally used for micro irrigation with low flow and long run times. Sprinkler zones should be assigned to A, B, or C.

Programs A, B, and C will stack operations. This means that if your run time for Program A overlaps B or C, then B will not start until A is completed and so on. If you want exact start times for all programs, make sure your total run time for each program can complete before the next program run is scheduled to start.

RUN MANUAL PROGRAM Button:

Press to initiate a watering operation when the programming dial is set in either the RUN or SYSTEM OFF position. The SmartLine controller will run Program A. Or, you can push the PGM button before you push the RUN MANUAL PROGRAM button to select the program you want to run. You can use the NEXT button to advance to other zones in a program that you have started. Run Manual Program will override any omits, delays or sensor pause.

Special Feature: *You can also use the RUN MANUAL PROGRAM button to start a continuous run operation. If you press and hold the RUN MANUAL PROGRAM button for 15 seconds, the selected program will operate in a continuous loop. In other words, it will keep running the program continuously until the dial is switched to SYSTEM OFF. This feature is only operable in the Standard mode.*

Display With Program Running: When a program is running, the screen will display: program that is operating; zone number that is operating; and run time remaining. An ORANGE LED indicates program is in PAUSE mode waiting for a programmed delay in the controller to expire (run/soak, master valve delay, zone to zone delay, omit time). The display will say PAUSE while waiting to begin watering.

Display With Dial In SYSTEM OFF Position: When the SmartLine controller dial is in the SYSTEM OFF position, the processor and clock continue to operate and all program values are retained in the non-volatile memory. In the SYSTEM OFF position, there is no power to valves and no automatic watering will occur. If the dial is in the SYSTEM OFF position at 12:00

SMARTLINE

Getting acquainted with your Smartline Controller 2.0

am, all Auto Adjust watering deficits are cleared and no new deficits will accumulate. The RUN MANUAL PROGRAM button can still be used to start a program. The RED LED will be displayed when controller is turned to SYSTEM OFF.

If you move the dial to any position other than RUN or SYSTEM OFF, and there is no control panel activity for 30 minutes; the controller will return to the RUN mode, and the display screen will show the idle default screen or will return to a program in progress that was interrupted.

Mode Button: Used to select Auto Adjust or Standard watering. During normal operation the MODE LED will display GREEN. It will change to ORANGE during a pause in operation and will display RED when SmartLine controller dial is turned to SYSTEM OFF.

Sensor Button: Used to activate or bypass optional sensors for rain, freeze, or wind. If these sensors are connected to your SmartLine controller, they will override watering operations if



Note: No watering will take place when the MODE LED is RED. However, the SmartLine controller will retain programs and current date/time. An ORANGE LED means watering is paused temporarily due to: run/soak, master valve delay, zone to zone delay, or omit hours. A program in operation will also pause if you turn the dial to any position other than RUN or SYSTEM OFF. The program in operation will resume (1) when you return the dial to RUN or (2) if there is no programming activity for 30 minutes.

the ACTIVE LED is selected. If your sensor/s have paused your system operation, the ACTIVE LED will be RED until the sensor/s allow watering to resume. In the event of a "rain" pause, the LED will change from RED to ORANGE for 48 hours of additional pause time before the LED displays GREEN and system operation resumes. During a sensor pause, Auto Adjust Watering deficits will decrement to 0 at the rate of 1" per hour. The sensor LED will display GREEN again when the sensor/s are no longer pausing your system operation.

If you wish to deactivate the sensors, use the SENSOR button to light the green BYPASS LED. Example: You wish to water after fertilizing and your rain sensor is still pausing the watering program. As long as the BYPASS LED is lit, the sensors will not pause your system operation.



Note: The SENSOR button can be used to bypass rain and freeze sensors regardless of whether your SmartLine controller is in Standard or Auto Adjust mode. The bypass feature does NOT override the SLW On-Site Weather Monitor's ability to continue to provide data to your SmartLine controller for Auto Adjust operation. It can only be used to bypass rain and freeze pause functions.

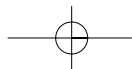

2.0 Getting acquainted with your Smartline Controller

SMARTLINE

2.2 Programming

Your SmartLine controller has two operating modes: **STANDARD** mode or Weathermatic's patented **Auto Adjust** mode. The Standard mode uses user assigned zone run times. The Auto Adjust mode overrides user assigned zone run times and calculates zone run times based on the location of the site, inputs by zone, and weather readings from the SLW weather monitor.

Note: Auto Adjust requires the optional SLW weather monitor.

Both the Standard mode and Auto Adjust mode use the user input daily start times, watering days, omit times/days, and several advanced functions (rain delay, zone to zone delay, and master valve settings).

Important Note: Zone run times must be entered for every zone in use for the controller to recognize the zone in either Standard or Auto Adjust modes.

Using the Programming Buttons

A **FLASHING DISPLAY** indicates that user choices are available. The ▲ and ▼ arrow buttons are used to scroll through numeric values or to make a choice of menu options.

NEXT and BACK Buttons: When watering zones are being programmed, the left side of the display will indicate the zone number. The NEXT and BACK buttons are used to scroll through the zones. If the flashing display indicates a menu selection rather than a numeric value, the NEXT button will open the menu for further programming. The BACK button will exit the menu and cause the chosen value to be saved in memory.

RAPID ADVANCE: While programming, holding down the ▲ or ▼ arrow button will cause the flashing display value to rapidly advance. Rapid advance can also be used with the NEXT and BACK buttons to rapidly advance through zones.

MENUS WITHIN MENUS: In cases where there are menus within menus, each press of the BACK button will return to the next higher menu until the top level menu of the dial position is reached.

A **VALUE CHANGE** will be entered in memory any time you (1) move to a different menu or (2) move the programming dial to a different position.

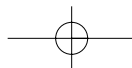

SMARTLINE**Programming for Standard Watering Mode 3.0****3.0 Programming for Standard Watering Mode****3.1 Set Time And Date**

Use ▲ and ▼ arrow buttons to change the flashing value for the hour. Scrolling past 12 will automatically change AM/PM.

Remember holding down the UP or DOWN arrow button will rapidly advance through the flashing menu. *(Note: For international users, if controller is powered by 230VAC, 50 Hz AC, display will read in international hours rather than AM/PM.)*

Use NEXT button to flash minutes. Use ▲ and ▼ arrow buttons to set minutes. Push NEXT to access calendar setting. Use ▲ and ▼ arrow buttons to set month/day/year. *(Note: For international users, the display will read day/month/year.)* Your SmartLine controller has a 100-year calendar, so when you have entered the correct date, the SmartLine controller will automatically display the correct day of the week. Your SmartLine controller will automatically adjust for leap years. A manual adjustment is required for Daylight Savings Time.

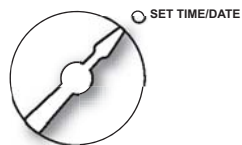
**3.2 Set Zone Run Times**

Your SmartLine controller will display remaining hours, minutes and seconds when a zone is watering.

However, in this position you are only required to set minutes (or hours and minutes) for each zone as desired for operation time. Seconds are not selectable.

Use NEXT and BACK buttons to select zone for run time setting. All zones are selectable from 1 minute to 9 hours and 55 minutes. Run times of OFF to 59 minutes are selectable in one minute increments. Run times of 1 hour to 9 hours 55 minutes are selectable in 5-minute increments. Use ▲ or ▼ arrow buttons to set flashing time values for each zone. If a zone is not to be used, set it to OFF. A zone with an OFF setting is OFF in both Standard and Auto Adjust modes.

Push PGM button to assign zone time in one or more programs. *Note: Program D is for concurrent operation for micro irrigation zones. Zones assigned to Program D cannot be assigned to Program A, B, or C. Display will say USED if attempt is made to enter time in A, B, or C for a zone already assigned operating time in D.*

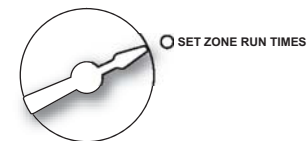

Note: If display shows "0 ZONES," this indicates no SLM4 modules are currently installed or have ever been installed under AC power with the control panel firmly closed.

3.0 Programming for Standard Watering Mode

SMARTLINE

Caution: If an unused zone is turned on and activates a pump start relay, the pump may overheat or cause a pipe to burst. To prevent operating a pump with no flow (dead heading), make sure all unused zones are set to OFF.

3.3 Set Daily Start Times

8 daily start times are available per program (4 on the SL800 model). The SmartLine controller has 4 programs, so you have 32 available start times for each 24-hour day. Check program icon in display to see whether you are working in A, B, C, or D. Use PGM button to move between programs. Use NEXT button to select start times 1 through 8 (1–4 for SL800) for each program. Use ▲ and ▼ arrow buttons to set each start time desired. *Note: Be sure you select the AM/PM time as desired by scrolling past 12.*

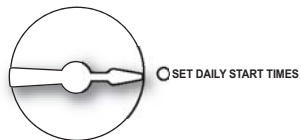

(For international users, the display will show international hours instead of AM/PM.) Start times are selectable in 10-minute increments.

Important: You need to know the total run time you have entered for each program to allow time for each cycle to complete before the next program begins. If a run time overlaps into the next start time, the SmartLine controller will stack the start times within each program and between programs, begin-

ning those operations at the time the previous operation is completed, beginning with start time 1 in Program A. If a concurrent program in D is running at the same time as a program in A, B or C, the display will alternately show the icon for both programs in the display.

All zones to be utilized must be assigned a run time whether you are using the Standard or Auto Adjust Mode. Your SmartLine controller will use Zone Run Times as the backup program for Auto Adjust.

3.4 Set Watering Days

In this dial position you can select a DAYS, INTERVAL, or ODD/EVEN schedule.

Use ▲ and ▼ arrow buttons to select which type of schedule you want in your SmartLine controller. Remember to check the Program (PGM) selection showing in the display. You can select a different watering schedule for



Note: Run/Soak period can reduce the need to set multiple start times for the purpose of preventing runoff. Using the combination of multiple start times and Run/Soak cycles can lead to extended watering windows since Run/Soak cycles are applied to each start time.

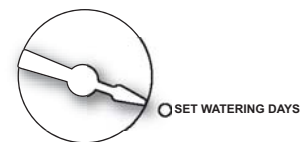

SMARTLINE**Programming for Standard Watering Mode 3.0**

each program if you wish.

If you select DAYS, then use the NEXT button to step through each day of the week and the ▲ and ▼ arrow buttons to select ON or OFF status for each day. Days selected to water will be displayed at the top of the display.

If you select an INTERVAL schedule, push NEXT button. The flashing number indicates the day interval for watering. SmartLine controller will allow an interval of 1 (every day) to 30 (water once every 30 days). After you have selected the interval you want, push NEXT to set the day you want the interval schedule to start on. Use ▲ and ▼ arrow buttons to select start day at top of display.

If you select ODD/EVEN day scheduling, push NEXT button and then use ▲ or ▼ arrow buttons to select watering on ODD or EVEN days. If ODD is flashing on the display when you turn the dial to another position, you have selected ODD. The same is true for EVEN. When you return the dial to RUN, you can view the next day that your schedule will run. The SmartLine Controller will run ODD or EVEN programming at the next available start time, even if it is on the same day that you set up the schedule. If you are using an ODD schedule, the SmartLine controller will not water on the 31st day of a month and February 29th of a leap year to prevent two consecutive watering days (31st and 1st or 29th and 1st).

3.5 Set Omit Times/Days/Dates (Optional)

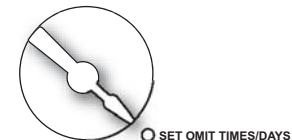

The omit settings are used to set a watering blackout period. For example, if you live in a municipality that restricts outdoor watering between 10:00 am and 6:00 pm, you can blackout that time period. If a watering program in progress is paused for a blackout period, the orange LED will display during the pause. The watering cycle will automatically resume at the end of the blackout period. Use the UP or DOWN arrow buttons to select OMIT:TIME, OMIT:DAY, and OMIT:DATE. You may choose any or all of these omit options.

If you want a watering blackout for the same period each day, select OMIT:TIME. Then push NEXT. A forward (>) arrow indicates the beginning time for the blackout. Use ▲ and ▼ arrow buttons to set beginning time. Then push NEXT. A reverse arrow (<) indicates the end time for the blackout. Use ▲ and ▼ arrow buttons to set ending time. The OMIT:TIME function will pause any active watering program until the blackout period has expired. Scrolling the beginning time (forward arrow) between 12:00 am and 11:50 pm causes NONE SET to appear and clears the omit time.

If you want to omit a specific day or days each week from watering schedules, select OMIT:DAY with the ▲ and ▼ arrow

3.0 Programming for Standard Watering Mode

SMARTLINE

buttons. Then push NEXT. Display will show a day of the week with Omit or Allow flashing. Use ▲ and ▼ arrow buttons to select Omit or Allow. Use NEXT or BACK to scroll between days of the week. Omitted days will be visible at the top of the display. Any running user program will be stopped at midnight in order to honor omit days or dates. Programs scheduled to start on an omit day will be skipped.

If you want to omit specific dates during the year, select OMIT: DATES. Then push NEXT. Enter the month and date. Push NEXT to enter up to 7 dates. Scrolling the month value between 12 and 1 causes mm/dd to appear and clears the omitted date. Any running user program will be stopped at midnight in order to honor omit days or dates.

Adjust, you are increasing or decreasing the 100% time value.

% settings in this mode are 10 to 300% in 5% increments. Use ▲ and ▼ arrow buttons to select % desired. Press PGM to choose program.

THIS COMPLETES PROGRAMMING FOR **STANDARD WATERING MODE**. RETURN THE DIAL TO THE RUN POSITION.

3.6 Seasonal % Adjust (Optional)

The Seasonal % Adjust feature allows the user to modify zone run times by program for each month to easily adjust watering for seasonal climate changes.

The time programmed for each zone in SET ZONE RUN TIMES is always the value for the 100% setting in Seasonal % Adjust. When you use the Seasonal %

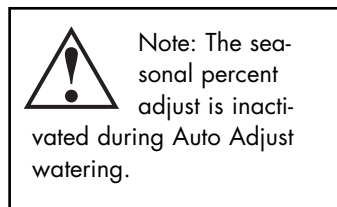

SMARTLINE

Programming for Auto Adjust Watering Mode 4.0

4.0 Programming for Auto Adjust Watering Mode

Weathermatic’s patented Auto Adjust overrides user assigned zone run times and calculates zone run times based on the location of the site, inputs by zone, and weather readings from the SLW Series On-Site Weather Monitor. Auto Adjust is designed to help you protect your landscaping, reduce wasteful run off, and minimize your water costs.



Warning: Auto Adjust positions on the dial can only be selected when the optional SLW Series On-Site Weather Monitor accessory is installed. Additionally, Standard Program Function must be set up completely (see Sections 4.1–4.4) before setting up Auto Adjust mode.

Auto Adjust Mode zone times for zones in use simply replaces the zone run times inputs with a calculated value.

Step 1: Set ZIP Code or Latitude

Auto Adjust operation first requires that the SmartLine Controller know “where in the world” it is located.

Users in the USA can set location by ZIP Code. Users outside of the USA can set location by latitude. Use ▲ and ▼ arrow buttons to select ZIP Code (USA) or LATITUDE. To find your latitude, see chart of World Latitudes on page 25.



ZIPCODE or LATITUDE ○

If you are setting a ZIP Code, push NEXT. Display will show 5 numerical positions for ZIP Code settings. Use ▲ and ▼ arrow buttons to set the flashing number. Then push NEXT to flash the next number. Use ▲ and ▼ arrow buttons to set second number. Continue process until all 5 numbers of your ZIP Code are set.

If you are outside the USA, you will enter LATITUDE. You can use the ▲ and ▼ arrow buttons to choose any latitude between 60 degrees south and 60 degrees north. 0 degrees setting is marked as EQUATOR.

Step 2: Activating the SLW Series On-Site Weather Monitor:

Verify the time and date are set and the ZIP Codes or Latitude are set on the SmartLine Controller before proceeding with SLW weather monitor activation.

On the SLW weather monitor, press and hold down the Rain Sense test tab in the center of the rain sensor for 15 seconds.

On the SmartLine controller, verify that the antenna icon appears on the bottom line of the LED display. The antenna indicates communication has been established.

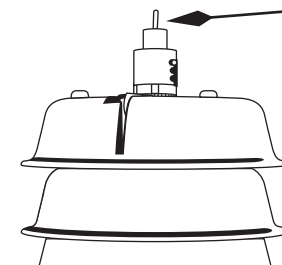

4.0 Programming for Auto Adjust Watering Mode **SMARTLINE**

The SLW weather monitor provides rain and freeze pause functions to prevent watering during periods of rain and freezing weather. The rain override will pause watering after a minimum of 1/8th inch of rainfall is received (the factory setting of 1/8th inch can be changed incrementally up to 1 inch by sliding the rain sensor into the desired position). The SLW weather monitor will also pause watering when the outside temperature drops to 35 degrees Fahrenheit (1.5 degrees Celsius). The Sensor LED will display RED during these rain or freeze periods. 24VAC power to the valves is reconnected when the when the temperature is again above 35 degrees F (1.5 degrees Celsius). However, after a rain event, the SmartLine controller will continue to pause watering for 48 hours after the rain sensor has disengaged, in order to prevent over-watering.

Step 3: MODE Button:

Press the MODE button on the control panel to place the SmartLine controller in the Auto Adjust mode. A GREEN LED on the Auto Adjust position will confirm that you have communicated with the SLW weather monitor. If there is no SLW weather monitor installed or ZIP Code or Latitude or time/date setting, pressing the MODE button will flash the Auto Adjust LED to RED and then return to the Standard mode. When this occurs, you can press and hold the MODE button to see a scrolling message indicating the reason Auto Adjust mode is not available.

Step 4: Enter Auto Adjust Data for Zones:

Enter Auto Adjust data for zones: Sprinkler Type, Plant Type, Soil Type, and MORE/LESS. The SmartLine controller cannot calculate run times without Auto Adjust data for each zone and without Zone Run Times assigned to each operational zone, which serve to back up Auto Adjust mode.

Sprinkler Type: In order to calculate run time, the controller must know the expected precipitation rate for each zone. Use NEXT and BACK buttons to move between zones. Use ▲ and ▼ arrow buttons to set zone to OFF or to specify the precipitation rate.

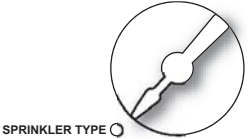

Precipitation rate can be entered two ways: by sprinkler type or by specific precipitation rate. If you do not know the specific precipitation rate for the zone, you can select the sprinkler type, or watering equipment used on that zone: Spray, Rotor, Drip, or Bubbler irrigation. The SmartLine controller will apply a default precipitation rate for the sprinkler type selected. If you know the specific precipitation rate expected for the zone, as stated by the sprinkler manufacturer,

SPRINKLER TYPE	DEFAULT PRECIPITATION RATE
SPRAY	1.0 inch per hour
ROTOR	0.5 inch per hour
DRIP	1.1 inches per hour
BUBBLER	2.3 inches per hour

SMARTLINE

Programming for Auto Adjust Watering Mode 4.0

you can use the ▲ or ▼ arrow buttons to scroll past the sprinkler types and select that number. For USA users, inches per hour will be displayed (.2 to 3.0 inches per hour). For international users, the controller will display precipitation numbers in centimeters per hour. As a rule in Auto Adjust mode, the lower the precipitation rate entered, the longer the zone run time will be to achieve required plant life needs.

Plant Type: This position is used to specify the type of plant material to be watered by each zone as an important component of determining the watering needs for each

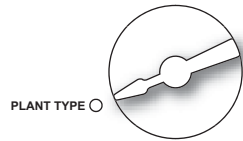

zone. Use the ▲ and ▼ arrow buttons to select plant type or percent for each zone. Press NEXT and BACK buttons to access each zone. Plant type selections are: **CTurf** (cool turf like bluegrass); **WTurf** (warm turf like St. Augustine); **Shrubs**; **Annuals** (floral beds); **Trees**; and **Native plants**. The SmartLine controller formula uses cool turf mowed at 4 to 6 inches tall as the base watering number (100%) or crop factor. The cool turf default is 80% considering average mowing heights of 2 to 3 inches, which result in less transpiration and lower water requirements. If you prefer more specific input, you can scroll past the plant types and use % designations of 10 to 300%. For example, a Native plant zone might be assigned 30% rather the default of 25%. As a rule in Auto Adjust mode, the higher the plant type percentage entered, the longer the zone run time will be to

achieve required plant life needs.

For maximum water savings, it is recommended that your sprinkler system be zoned with a separate valve for each type of plant material. If you have mixed types of plants in a single zone, you will need to select which type of plant to use in the determination of water requirements.

PLANT TYPE	DEFAULT %
CTURF	80%
WTURF	60%
SHRUBS	60%
ANNUALS	150%
TREES	80%
NATIVE	25%

Soil Type: Soil settings for soil type and degree of slope are used to enable your SmartLine controller to automatically calculate the maximum length of a zone run time before

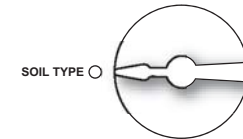

pausing watering for a calculated period to allow the water to soak into the soil. These Run/Soak (also called Cycle/Soak) periods based on industry standard formulas reduce wasteful runoff caused by watering more than the soil can absorb. The Run/Soak feature included in Advanced Functions can be manually entered for use with the Standard mode. However, in the Auto Adjust mode, the SmartLine controller will automatically calculate Run/Soak times with soil inputs made at the soil type position on the dial. Run/Soak settings made in Advanced Functions are not

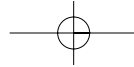

4.0 Programming for Auto Adjust Watering Mode **SMARTLINE**

active when controller is in Auto Adjust mode.

Use the ▲ and ▼ arrow buttons to select **Clay**, **Loam** or **Sand** soil type for each zone.

After you have selected a soil type for a zone, push NEXT button. You can now use the ▲ and ▼ arrow buttons to select degrees of slope (elevation change) for each zone. Set each zone for 0 to 25 degrees of slope based on the chart below. Push NEXT again after making the slope entry to advance to the next zone.

SLOPE/ GRADE	DEGREE OF SLOPE	
SLIGHT	1-5	▬
MILD	6-10	▬▬
MODERATE	11-15	▬▬▬
STEEP	16-20	▬▬▬▬
EXTREME	21-25	▬▬▬▬▬

Use NEXT and BACK buttons to move between zones.

Note: Run/Soak period can reduce the need to set multiple start times for purpose of preventing runoff. Using the combination of multiple start times and Run/Soak cycles can lead to extended watering windows since Run/Soak cycles are applied to each start time.

More/Less: When your SmartLine controller is set in Auto Adjust mode, the Seasonal % Adjust in the Standard mode is inactivated since the automatic adjustments are made

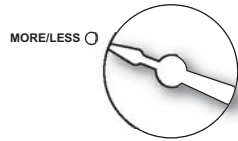

daily rather than monthly. You can use MORE/LESS to fine tune the run time calculation by zone in the SmartLine controller by -50 to +25%. Use ▲ and ▼ arrow buttons to select % adjustment. Use NEXT and BACK buttons to move between zones.

This feature can be useful to reduce run time adjustments for shady and partially shaded zones. The table below may be used for general shade guidelines.

Other factors may result in needing to use MORE/LESS for fine tune adjustments including sprinkler efficiency, zone efficiency, and wind. Sprinkler efficiency varies between types of sprinklers and the manufacturer's design. Zone efficiency varies based on the design layout of sprinklers in a zone, sometimes overlapping or sometimes not. High winds can serve to dry out plant and soil to increase the need for water. For optimum results considering the many unique variables in each zone, users should periodically monitor plant life health and water usage, especially after initial controller setup, so proper adjustments can be made.

SHADE LEVEL	MORE/LESS %
TOTAL SHADE	-50%
FILTERED SHADE	-20%
MORNING SHADE	-10%
AFTERNOON SHADE	-30%

THIS COMPLETES PROGRAMMING FOR **AUTO ADJUST**. RETURN THE DIAL TO THE RUN POSITION.

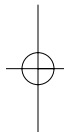
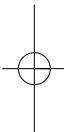
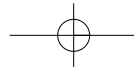

SMARTLINE

Manual Start Functions 5.0

5.0 Manual Start Functions

The SmartLine controller has two dial positions for manual system starts:

Manual Zone

Manual Zone allows user to water a single zone for specified period of time. Use NEXT and BACK buttons to select zone. Use ▲ and ▼ arrows to select run

time for the zone. A zone can be operated with the Manual Zone function regardless of whether the zone has an assigned run time. **You must return dial to RUN for Manual Zone operation to begin.** All manual watering operations will override watering day settings, omit settings, and rain/freeze events.

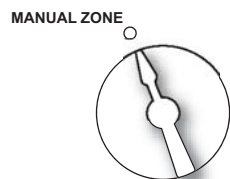

Manual Test

The Manual Test can be used to set a test run time for all zones which have an assigned zone run time in any program. Any zone without an assigned zone run time will NOT run in the Manual Test. Use

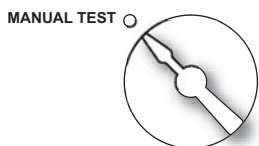

▲ and ▼ arrow buttons to set Manual Test run time. The Manual Test can be set to run a minimum of 10 seconds or a maximum of 10 minutes. **You must return dial to RUN for Manual Test operation to begin.**

The Manual Test will also detect open circuits (less than 30 mA draw) on any used zone or a short on any output (master valve or zone). If the display indicates FAULT when the dial is in the Manual Test position, refer to Advanced Functions procedures to identify the fault.

In addition to manual operation using Manual Zone and Manual Test, you can run a program by pressing and holding the ▲ arrow button, also labeled RUN MANUAL PROGRAM. Be sure to use the PGM button to select the specific program you choose to run manually. RUN MANUAL PROGRAM can be stopped by pressing the UP arrow button or moving the dial out of the RUN position. If you push the RUN MANUAL PROGRAM button and press and hold down for 15 seconds, the selected program will operate in a continuous loop. In other words, it will keep running the program continuously until the dial is switched to SYSTEM OFF. This feature is only operable in the Standard mode.

All manual watering operations will override watering day settings, omit settings, and rain/freeze events.

6.0 Advanced Functions **SMARTLINE**

6.0 Advanced Functions

Advanced Functions provides information and allows more technical inputs commonly used by professional installers. Advanced Functions contains menus within menus. Each press of the BACK button will return you to a higher level until the top level of the Advanced Functions dial position is reached.

Refer to the chart below for the location of features within the menus. Note: Diagnostic tests, rain delay, run/soak, ZN:ZN DLY, MV:ZN DLY and MV/ZONE features are only on SL1600 and SL4800 SmartLine models (not included in SL800).

6.1 FAULT

This feature is used to identify problems that may require attention or repair in order to insure proper operation of the system. Use NEXT button to view the type of fault. If more than one fault exists, you can use the ▲ and ▼ arrow buttons to search for additional faults. Use NEXT button one more time and it will flash KEEP. If you want to clear the fault, hit the UP arrow and it will flash CLEAR. If you turn the dial out of the Advanced Functions positions while CLEAR is flashing, the fault icon on the display will disappear. However, if the cause of the fault is not corrected, the controller will continue to skip watering a zone with a fault and will resume the flashing FAULT icon on the display each time that zone is operated.

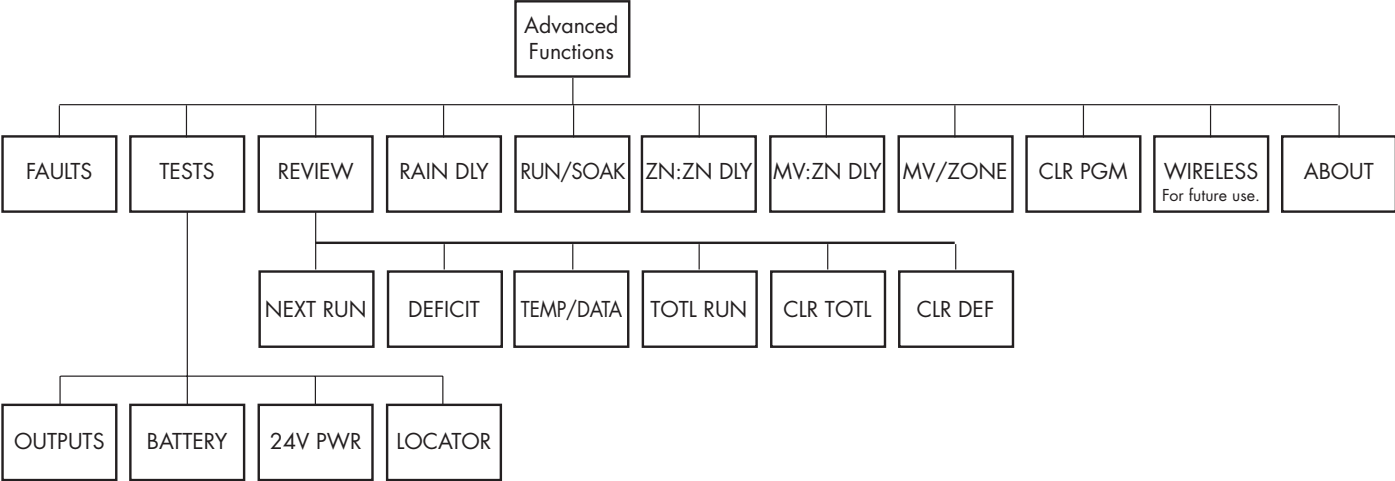

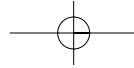

SMARTLINE

Advanced Functions 6.0

SCROLLING FAULT MESSAGE	FAULT DESCRIPTION
ZONE XX SHORT	<p>OUTPUT SHORT CIRCUIT: A load placed on any output that results in a current draw exceeding the skip current setting will result in a fault within 3 AC cycles after the output is turned on. The output will be skipped until the next watering program attempts to use it. If the MV/P output is shorted, all zones using it will effectively be skipped. The fault indication can be manually cleared or will be automatically cleared if the short condition goes away; and the output turns on successfully. See Section 6.2.1 Outputs for instructions on reading actual current.</p>
ZONE XX OPEN	<p>OUTPUT OPEN CIRCUIT: If a used zone exhibits a load that results in a current draw less than 30 mA during a scan test, a fault is declared, but operation continues normally. The fault indication can be manually cleared or will be automatically cleared if a load exceeding 30 mA is placed on the output, and the output turns on successfully. See Section 6.2.1 Outputs for instructions on reading actual current.</p>
NO RECENT CONTACT WITH WEATHER MONITOR	<p>COMMUNICATIONS FAILURE: If the SmartLine controller is in Auto Adjust mode, and the daily high/low temperature has not been received by midnight, the communication fault is set. Also, if the battery in the SLW weather monitor is dead, the communication fault is set. If 5 days pass without communication, the controller will revert to the Standard mode Zone Run Times. The fault indication can be manually cleared or will clear automatically once communication is received.</p>
REMOTE BATTERY FAILURE	<p>If the SmartLine controller receives communication from the SLW weather monitor that indicates the remote battery is low, the fault is set. The fault indication can be manually cleared, or will clear automatically if the SLW weather monitor sends another message that indicates a good battery. The fault will also clear if no communication is received for a full day (i.e. communication failure). See Section 7.2 Replacing SLW Series Weather Monitor 9V Battery.</p>
ZONE XX INSUFFICIENT WATERING OPPORTUNITY	<p>INSUFFICIENT WATERING OPPORTUNITY: If the SmartLine controller is in Auto Adjust mode, and a daily deficit is calculated that results in a zone watering deficit in excess of the 1.5" maximum, the deficit is capped to the maximum and the fault is set. The calculation can also occur as part of the deficit gap recovery process, which happens when the SmartLine controller loses power for over a day and then recovers. The fault is cleared manually.</p>

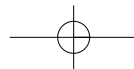

6.0 Advanced Functions

SMARTLINE

6.2 TESTS

Your SmartLine controller can assist you with several diagnostic functions by pressing NEXT when TESTS appears.

6.2.1 OUTPUTS

Use ▲ arrow to select OUTPUTS function. Then use NEXT and BACK buttons to scroll through MV and Zone Valves to view AC Amp reading for each valve. Scroll back to OUTPUTS display to move to next diagnostic function. Typical range is 150 to 350 mA per valve with a valve connected. Current exceeding 350 mA per valve could be an indication of a partial short. Current readings less than 30 mA will indicate an open circuit. Note: If you have more than one valve on a zone, the SmartLine controller will measure total current for the combined valves.

6.2.2 BATTERY

Use ▲ arrow button and Battery will flash. Use NEXT button and you will see the DC V reading for the backup battery in the SmartLine controller. A minimum of 7.5 volts is required to power the processor and display. If the reading is less than 7.5 volts, the battery should be replaced. This function does not provide voltage readings for the 9V battery in the optional SLW weather monitor. However, if you turn the dial to any Auto Adjust programming position, the battery icon reading you see in the display is for the battery in the SLW weather monitor.

6.2.3 24V PWR

This function displays output voltage at the transformer. Normal reading is 24 to 30 volts AC.

6.2.4 LOCATOR

This feature will create a "chatter" for a selected valve as a convenient method of locating buried valves. Use NEXT and BACK buttons to scroll to the valve you want to "chatter."



Note: If you are not utilizing a master valve, you must turn off the system water pressure at the manual cut-off valve or water meter for this feature to work. Pressure must be off while attempting to "chatter" a valve. The SmartLine controller will automatically turn off MV output when a "chatter" test is initiated.

6.3 REVIEW

6.3.1 NEXT RUN

NEXT RUN is the total amount of run time Auto Adjust has calculated for each zone for the next watering day based on the deficit numbers and is available for review when you are using Auto Adjust. NEXT RUN times will return to zero after each watering day's cycles are complete. Use the NEXT and BACK buttons to review the NEXT RUN time for each zone.

SMARTLINE**Advanced Functions 6.0****6.3.2 DEFICIT**

Deficit is the amount of water (displayed in inches) that needs to be replaced for your plant material due to water loss through evapotranspiration – evaporation from soil and transpiration from plants. Your SmartLine controller will calculate the water deficit each day at midnight based on data communicated to it by the SLW series weather monitor at 11:50 pm of the prior day. The water deficit will continue to accumulate until the next scheduled watering cycle and will return to a zero reading when watering is finished. The SmartLine controller uses an internationally recognized formula called the Hargreaves formula for calculating evapotranspiration.

When Advanced Functions is displaying DEFICIT, use NEXT and BACK buttons to view deficit for each zone. The NEXT or BACK buttons will also return you to the DEFICIT level. When display is at the DEFICIT level, you can then use the UP arrow button to move to NEXT RUN readings.

If you wish to reduce the deficit numbers, press and hold down either the ▲ or ▼ arrow button for 5 seconds. This allows you to use the ▼ arrow button to reduce the latest deficit for the zone to as low as 0 inches.

Deficit is only available for



Note: If the dial is in the SYSTEM OFF position at 12:00 am, all Auto Adjust watering deficits are cleared and no new deficits will accumulate until dial is moved from SYSTEM OFF position.

review when you are using Auto Adjust mode.

6.3.3 TEMPDATA

TEMPDATA provides the daily high/low temperature readings in Fahrenheit (Celsius for export) from the SLW weather monitor for the past 5 days. Press NEXT to view readings for the prior day. Press NEXT again to view the readings from one day before the prior day followed by the daily high and daily low. Continue pressing NEXT to view up to 5 days of temperature history.

6.3.4 TOTAL RUN

TOTL RUN is the total run time for each zone since the date shown (default date in the SmartLine controller is January 1, 2000 shown as 01/01/00). You can review TOTL RUN for either the Standard or Auto Adjust modes. After you select TOTL RUN with the UP arrow button, use NEXT to view the date when TOTL RUN accumulation began. Use NEXT again to view the total run times for each zone.

You can use the NEXT and BACK buttons to move through the zones. After you go through all the zone positions, use the NEXT button one more time to take you back to the TOTL RUN screen.

6.0 Advanced Functions

SMARTLINE

6.3.5 CLR TOTL

CLR TOTL is used to clear and reset the total run time for each zone shown in the TOTL RUN menu.

From the CLR TOTL menu, press NEXT and the display will show KEEP. If you want to clear the TOTL RUN time and reset the accumulation date, press either the ▲ or ▼ arrow button to display CLEAR. With CLEAR showing in the display, either press NEXT or BACK or turn the dial to complete the clearing and resetting. This feature will stop accumulations on a zone after 255 hours of cumulative zone run time.

6.3.6 CLR DEF

To clear deficits, press NEXT. Use ▲ or ▼ arrow buttons to select KEEP or CLEAR. Press NEXT or BACK to exit CLEAR DEFICITS.

6.4 RAIN DLY

The rain delay feature allows user to globally suspend watering operations for all programs for a selected number of days in either the Standard or Auto Adjust watering modes.

Use ▲ and ▼ arrow buttons to select 1 to 7 days for watering suspension. The watering blackout will automatically be cleared from the SmartLine controller after the assigned days have expired and watering will resume at the next available start time. Auto Adjust watering deficits will reset at zero and will not resume accumulation until the delay has ended.

6.5 RUN/SOAK

The purpose of Run/Soak is to break up long run times that often cause wasteful runoff. The Run/Soak is programmable for each program if you are using the Standard watering mode. Note: If you are using Auto Adjust, these inputs are not used since the Run/Soak period is automatically calculated.

Use NEXT button to access RUN time allowed before the zone watering pauses for the specified soak time. Use PGM button to select program. Use ▲ and ▼ arrow buttons to set RUN time from OFF to 30 minutes (SmartLine controller default is OFF). Use NEXT button to access soak time required for water to infiltrate into soil before zone watering is continued. Use the ▲ and ▼ arrow buttons to set soak time from 1 minute to 2 hours in one-minute increments.

6.6 ZN:ZN DLY

This function allows user to set delay times between zone starts for use in systems with slow closing valves or pump systems that are operating near maximum flow or have slow well recovery. Use ▲ and ▼ arrow buttons to change value. Adjustable in one-minute increments from 0 (the SmartLine controller



Note: The Master Valve/Pump Start circuit will operate during the first 5 seconds of any programmed delay to aid in closing of the valve and to avoid unnecessary cycling of the pump. The 5 second period is programmable in the MV:ZN DLY setting. (See Section 6.7)

SMARTLINE**Advanced Functions 6.0**

default setting) to 30 minutes; adjustable in 10 minute increments in settings from 30 minutes to 3 hours.

6.7 MV:ZN DLY

(Master Valve Advance Open and Delayed Close): This function allows the user to set a delay time between the opening of the master valve and the opening of the first zone valve as well as a delay between the closing of the last zone valve and the closing of the master valve.

Use the NEXT button to enter menu. Select setting for the ON Delay or OFF Delay by pressing NEXT. Use ▲ and ▼ arrow buttons to select delay time. Use arrow buttons to set ON Delay time from 0 seconds to 1 minute in 1 second increments. OFF Delay can be set from 0 seconds to 3 minutes in 1 second increments.

6.8 MV/ZONE

This feature is used to indicate which zones will use the master valve/pump start relay. Use NEXT button to set each zone ON or SYSTEM OFF (SmartLine controller default is master valve ON for all zones). Use ▲ and ▼ arrow buttons to select ON or OFF. Use NEXT button to select zone.

Caution: If an unused zone is turned on and activates a pump start relay, the pump may overheat or cause a pipe to burst. To prevent operating a pump with no flow (dead heading), make sure all unused zones are set to OFF.

6.9 CLR PGM

This feature allows the user to clear all programmed values specific to a selected program. All zone run times and daily start times will be set to OFF; watering days will default to Days of the Week (all on); Season % will equal 100% for all months and Run/Soak will be OFF. Omit times/days and Auto Adjust settings are not reset when clearing a program.

From the CLR PGM menu, press NEXT and the display will show KEEP. Use PGM button to select program to be cleared. Then, press either the ▲ or ▼ arrow button to display CLEAR. With CLEAR showing in the display, either press NEXT or BACK or turn the dial to complete the clearing of the selected program. Likewise, with KEEP showing in the display, either press NEXT or BACK or turn the dial to keep the selected program.

6.10 WIRELESS

Reserved for future use with wireless remote options.

6.11 ABOUT

Provides information on software version in the SmartLine controller.

7.0 Troubleshooting **SMARTLINE**

7.0 Troubleshooting

7.1 Total Reset Procedure For The SmartLine controller

A total reset will clear all programming data in the SmartLine controller including the time/date setting. All settings will return to factory default.

- Turn dial to Advanced Functions.
- While pressing and holding both the ▲ and ▼ arrow buttons, use an open paper clip to push in the Reset switch located on the back of the control panel. Release the reset button while continuing to press and hold both the ▲ and ▼ arrow buttons.
- Once the display shows CLEARING release the ▲ and ▼ arrow buttons.
- Reprogram SmartLine controller.

 **Note:** If you only want to clear the values in one program only, you should use the Clear Programs (CLR PGM) function located in Advanced Programming (See Section 6.9).

7.2 Replacing SLW weather monitor 9V Battery

- For models SLW20 and SLW25, remove the two Phillips screws that hold the SLW weather monitor access panel in place (taking care not to lose them) and remove the access panel.

- For models SLW10, SLW15, open snap-in door on the bottom of the SLW weather monitor to access battery
- Replace the existing battery with a new 9V alkaline battery.
- You will now need to re-initialize the monitor. Press the left button on the monitor panel and wait 3 seconds. You should see a series of 3 GREEN blinks from the LED if communication is re-established with the controller.
- Return to the controller and push the MODE button to place the controller back in the Auto Adjust position. If communication with the monitor is successful, the Auto Adjust GREEN LED will light and the antenna icon will appear in the display.

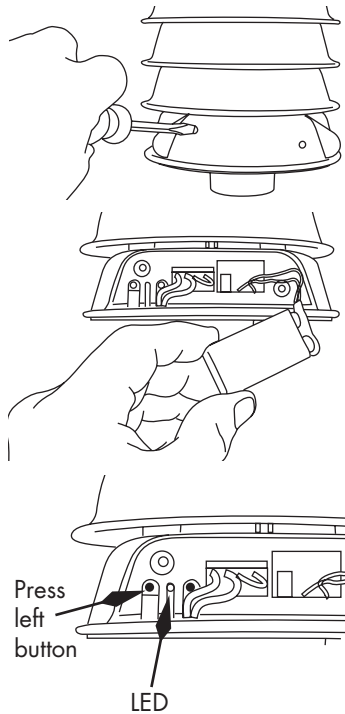

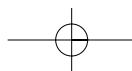

SMARTLINE

Troubleshooting 7.0

PROBLEM	CAUSES	SOLUTIONS
<p>Controller won't allow entry to Auto Adjust and/or no antenna icon on display</p>	<p>System requires installation of SLW weather monitor</p> <p>SLW weather monitor not initialized to controller</p> <p>Missing required Auto Adjust settings</p> <p>9V battery in SLW weather monitor is drained</p> <p>Communication cable problem</p> <p>Defective SLW weather monitor</p> <p>Defective SLHUB communication hub</p>	<p>Install optional SLW weather monitor</p> <p>Initialize SLW weather monitor according to instructions in Auto Adjust section</p> <p>Push and hold down MODE button for a scrolling message indicating needed information. Enter needed information for time, date, and ZIP Code or Latitude</p> <p>Replace battery as shown in Section 7.2</p> <p>Check cable and connections at controller</p> <p>Replace SLW weather monitor. If SmartLine controller has no communication for 5 days, it will revert to Standard program settings</p> <p>Replace SLHUB communication hub</p>
<p>No Display</p>	<p>No power to controller</p> <p>No 24V power from transformer</p>	<p>Check power wiring, breaker, and be sure control panel is firmly closed. Replace 9V battery</p> <p>Replace transformer. Likely power surge damage</p>
<p>FAULT icon on display</p>	<p>Shorted or open condition on a zone(s)</p> <p>Shorted MV/P</p> <p>Insufficient watering opportunity</p> <p>(Continued on next page.)</p>	<p>Check solenoid(s) and wiring (turn dial to Advanced Functions for fault information in Sec 6.1)</p> <p>Check solenoid(s) and wiring</p> <p>Check programming watering days, verify omit settings are not excessive, and review accuracy of Auto Adjust settings for sprinkler and plant type</p>

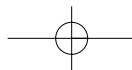

7.0 Troubleshooting **SMARTLINE**

PROBLEM	CAUSES	SOLUTIONS
<p>FAULT icon on display</p>	<p>No deficit accumulation in Auto Adjust mode</p> <p>No recent communication</p>	<p>Verify deficits as shown in Section 6.3.2</p> <p>Verify SLW weather monitor installation according to instructions in Auto Adjust</p>
<p>Display shows zone is running but no sprinklers are operating</p>	<p>Water supply to system is shut OFF</p> <p>Valve failure</p> <p>Open or disconnected wire</p>	<p>Turn on water supply to system</p> <p>Verify valve operation</p> <p>Run MANUAL TEST as shown in Section 5.0</p> <p>Verify FAULT icon is shown display. Turn dial to Advanced Functions to determine location of fault</p>
<p>SmartLine controller does not turn on zone when expected</p>	<p>Zone set to OFF</p> <p>Dial set to SYSTEM OFF</p> <p>No zone run time set; no daily start time set</p> <p>Sprinkler Type set to OFF (in Auto Adjust mode)</p> <p>Omit times/days are activated</p> <p>Rain or freeze sensor has stopped watering (Sensor LED is red; Sensor LED is orange during 48 hour extended rain delay period) if SLW weather monitor is utilized.</p>	<p>Set zone run time</p> <p>Position Turn dial to RUN</p> <p>Program zone run time and daily start time</p> <p>Program Sprinkler Type setting</p> <p>Verify omit times/days</p> <p>Replace sensor if faulty</p> <p>Select BYPASS mode if desired</p>

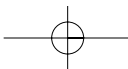

SMARTLINE

Troubleshooting 7.0

PROBLEM	CAUSES	SOLUTIONS
<p>SmartLine controller does not turn on zone when expected</p>	<p>Sensor jumper is removed and no sensor is connected (Sensor LED is red)</p> <p>Sensor wires have been cut (Sensor LED is red)</p> <p>Zone comes on at unexpected time</p> <p>Stacked program has commenced normal operation</p> <p>Time of day or date not set properly</p> <p>Watering days or omit days/dates not set properly</p> <p>Run/Soak feature has extended watering window</p> <p>Controller does not operate zone for expected run time</p> <p>Auto Adjust mode has calculated a different run time than expected</p> <p>Module not installed</p> <p>No initial AC power-up of controller</p>	<p>Install jumper wire between SEN terminals Select BYPASS mode if desired</p> <p>Repair wires</p> <p>Program daily start times not set properly or multiple start times set. Check all programs and daily start times</p> <p>Modify settings (such as daily start times, zone run times) to prevent stacking if undesirable</p> <p>Review/set time of day and date</p> <p>Review/set watering days or omit days/dates</p> <p>Normal operation to allow water infiltration and prevent run off</p> <p>Pause for Run/Soak in progress. This is normal operation to allow water infiltration and prevent runoff</p> <p>Normal operation of Auto Adjust mode to match watering to plant requirements</p> <p>Install module</p> <p>Connect AC power and close control panel</p>
<p>Display shows 0 ZONES</p>	<p>Defective module</p>	<p>Replace module in zone 1-4 position</p>

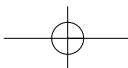
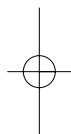

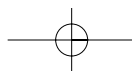

Appendix **SMARTLINE**

World Latitudes

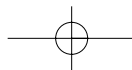
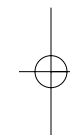
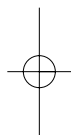
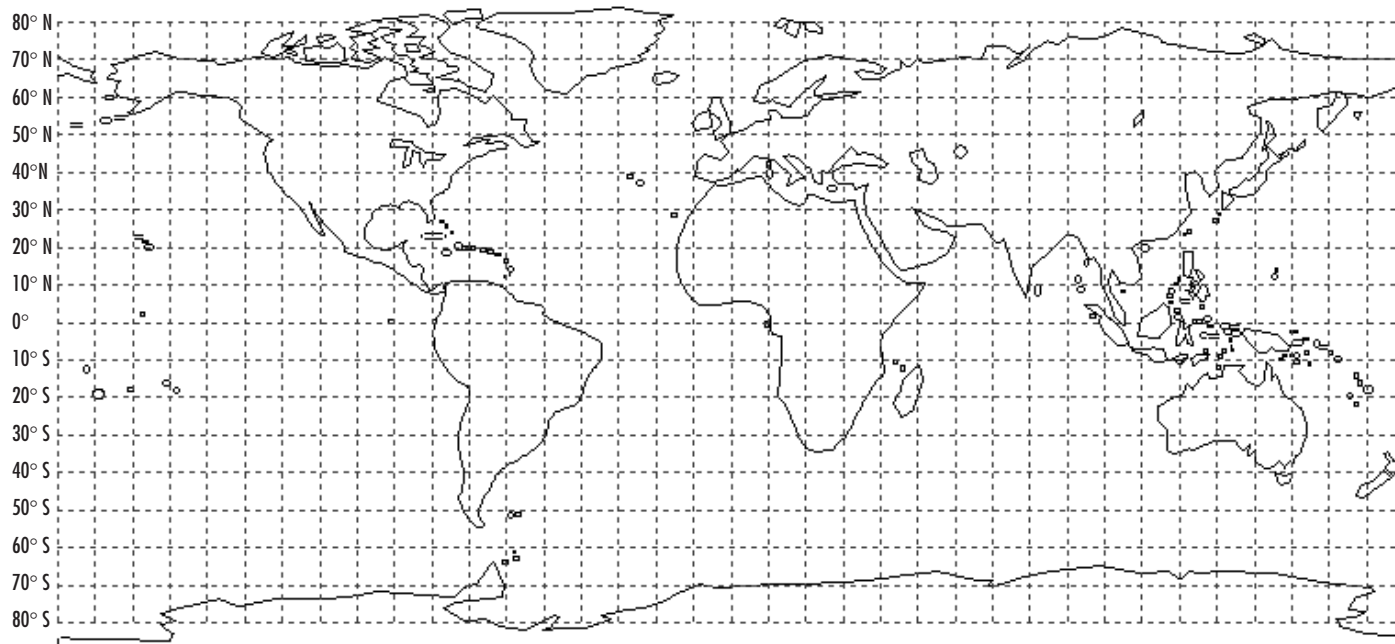

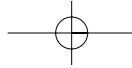

SMARTLINE

Notes

Notes:

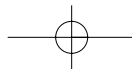
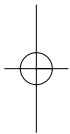

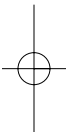

Basic Programming (Applies to both Standard and Auto Adjust Watering Schedules.)

	Program A	Program B	Program C	Program D
Days of the week	S M T W T F S	S M T W T F S	S M T W T F S	S M T W T F S
Odd/Even	<input type="checkbox"/> Odd <input type="checkbox"/> Even	<input type="checkbox"/> Odd <input type="checkbox"/> Even	<input type="checkbox"/> Odd <input type="checkbox"/> Even	<input type="checkbox"/> Odd <input type="checkbox"/> Even
Interval (Every 1-30 days)	____ days	____ days	____ days	____ days
Omit Days/Dates/Times	Days: _____	Dates: _____	Times: From>	To<
Daily Start Times	1 ____ 5 ____ 2 ____ 6 ____ 3 ____ 7 ____ 4 ____ 8 ____	1 ____ 5 ____ 2 ____ 6 ____ 3 ____ 7 ____ 4 ____ 8 ____	1 ____ 5 ____ 2 ____ 6 ____ 3 ____ 7 ____ 4 ____ 8 ____	1 ____ 5 ____ 2 ____ 6 ____ 3 ____ 7 ____ 4 ____ 8 ____

Standard Watering Schedule

Zone	Location	Program A Zone Run Time	Program B Zone Run Time	Program C Zone Run Time	Program D Zone Run Time
1					
2					
3					
4					
5					
6					
7					
8					
9					
10					
11					
12					
13					
14					
15					
16					

Seasonal % Adjust

PGM	Jan	Feb	Mar	Apr	May	Jun	Jul	Aug	Sep	Oct	Nov	Dec
A	____%	____%	____%	____%	____%	____%	____%	____%	____%	____%	____%	____%
B	____%	____%	____%	____%	____%	____%	____%	____%	____%	____%	____%	____%
C	____%	____%	____%	____%	____%	____%	____%	____%	____%	____%	____%	____%
D	____%	____%	____%	____%	____%	____%	____%	____%	____%	____%	____%	____%

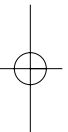
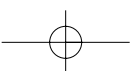
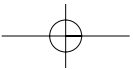

Auto Adjust Watering Schedule

ZIP Code/Latitude _____

Zone	Location	Sprinkler Type	Plant Type	Soil	Soil Type	Slope	More/Less
1							
2							
3							
4							
5							
6							
7							
8							
9							
10							
11							
12							
13							
14							
15							
16							

SMARTLINE

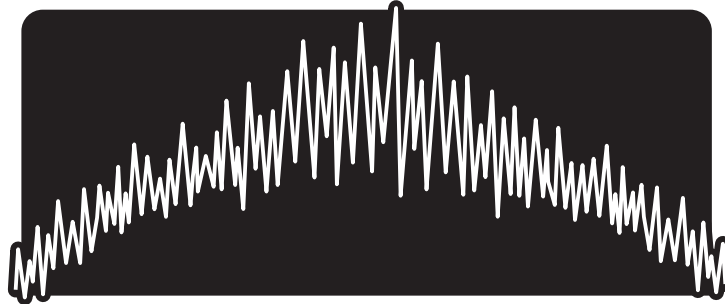

Part 000000